

**C  
A  
T  
A  
L  
O  
G  
O**

**Microcuscinetti**

**per**

**apparecchiature**

**dentali**

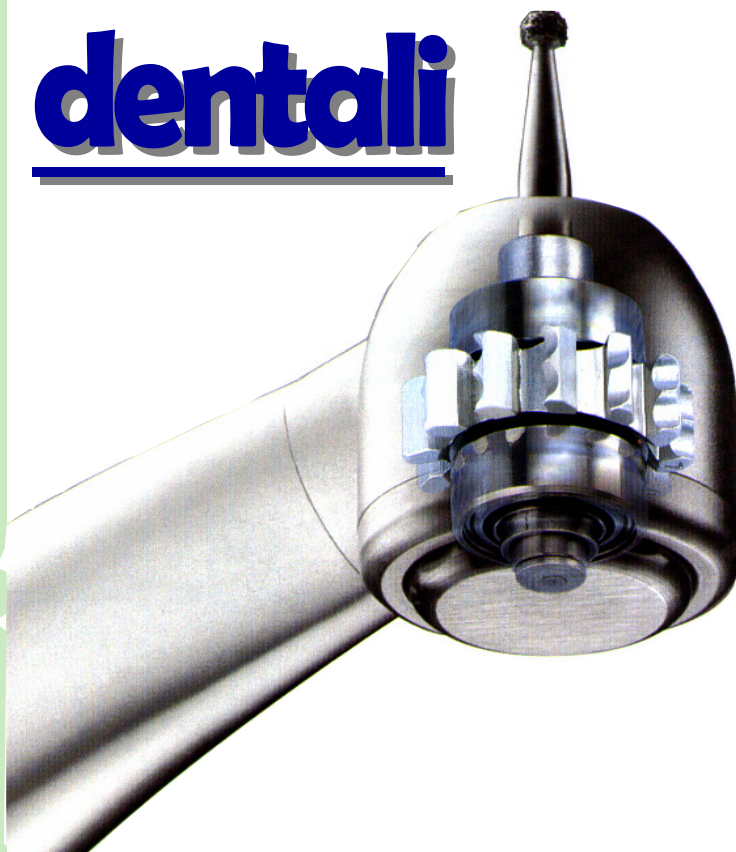

**ERNESTO RAAB SRL**



**2009**

Via Ghisalba, 13 -  
20021 Ospiate di Bollate (MILANO)  
Tel.: 0238303175 - Fax : 0238303207  
<http://www.ernestoraab.it>  
e-mail: [cuscinetti@ernestoraab.it](mailto:cuscinetti@ernestoraab.it)

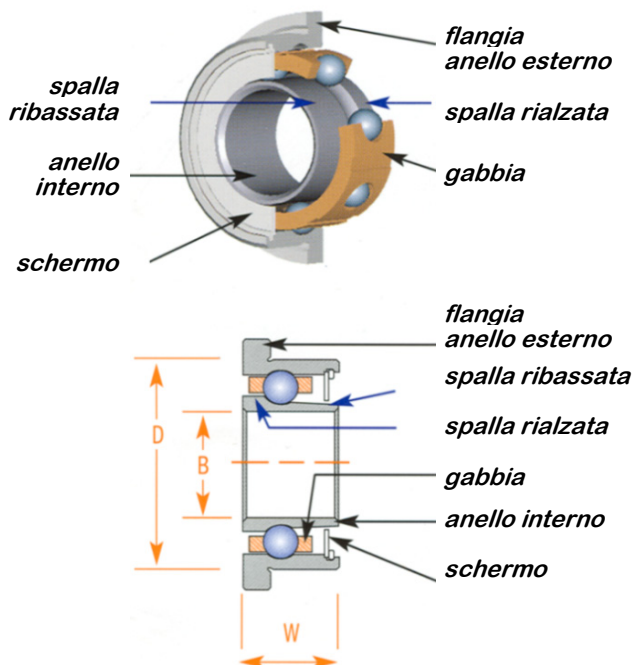

## IL CUSCINETTO ANGOLARE

E' composto da gabbie simmetriche che aumentano le prestazioni e la durata del cuscinetto, le cui sfere sono completamente supportate dalla gabbia.

I cuscinetti angolari devono essere precaricati assialmente con una molla di compensazione oppure con "O-Ring" per assicurare contatto con la spalla della pista in rilievo.

## IL CUSCINETTO RADIALE

E' meno costoso e più facile da montare rispetto al cuscinetto .  
Ha le piste di rotolamento a gola profonda e simmetrica che garantisce l' allineamento durante il rotolamento ed il montaggio nella turbina.

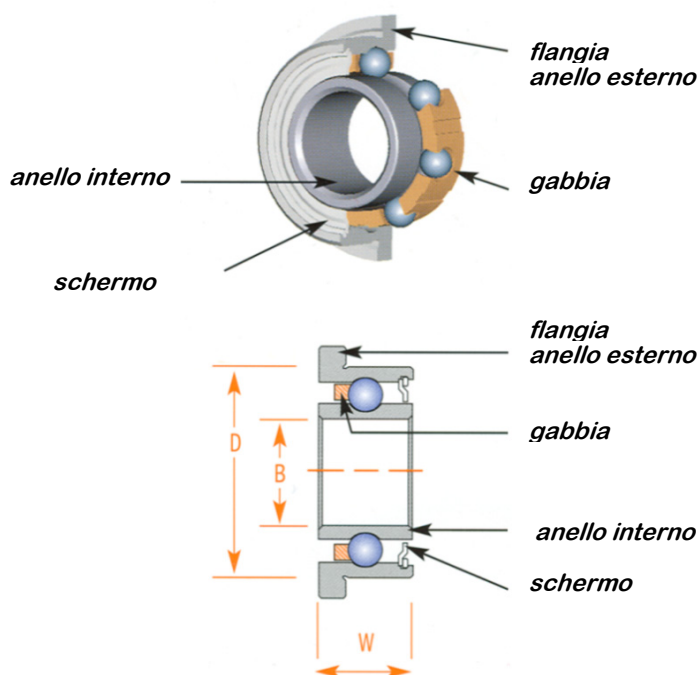

## NOMENCLATURA

**DR****13 A****5****G**

. **DR** - Determina il tipo, la configurazione ( DA = Angolare o DR = Radiale )

. **13 A** - Identifica la struttura del cuscinetto (Cilindrico, Flangiato, Ribassato o Unico )

. **5** - Identifica il tipo di gabbia ( 1 = Fenolica, 2 = Torlon, 3 = Minipar III, 4 = Miniwear e 5 = Everclave )





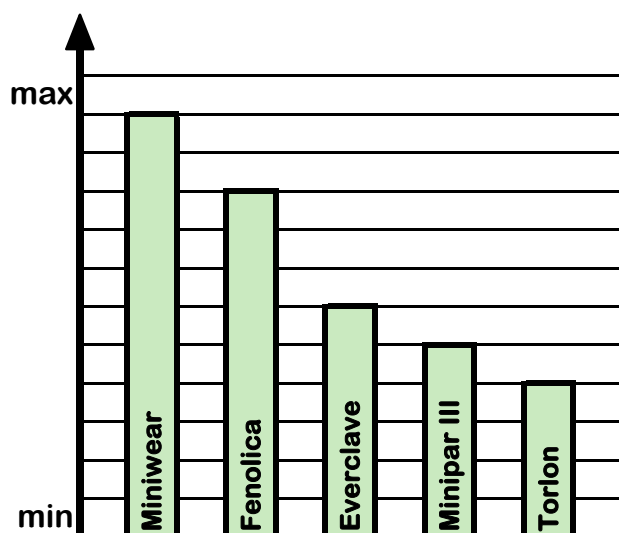



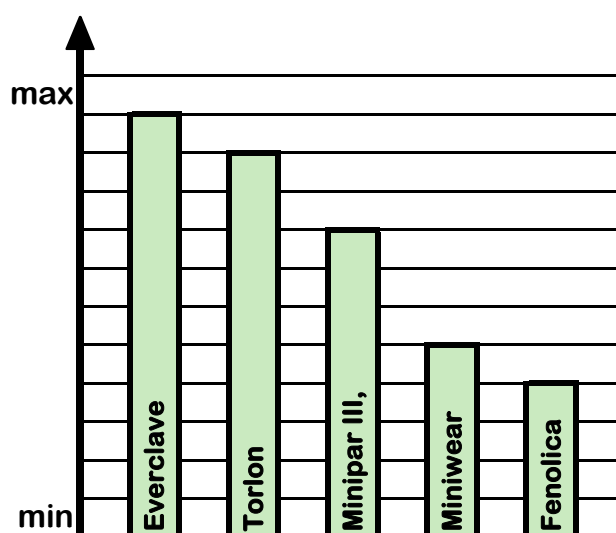

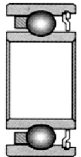
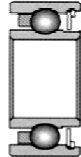
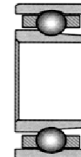
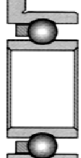
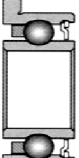
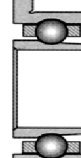
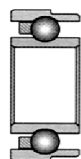
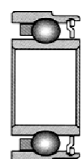

. **G** - Indica il tipo di lubrificante ( L = olio, G = grasso )

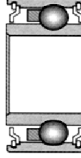

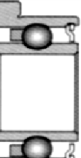

durata

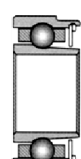
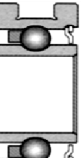
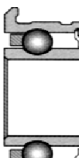





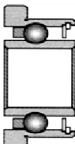

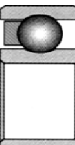
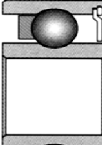
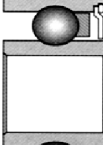
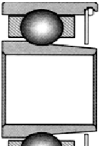
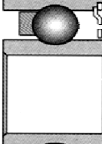
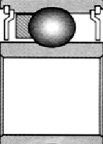

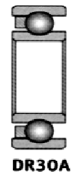

resistenza all'autoclave

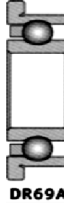

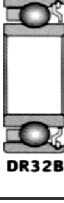

	TIPO	MISURE (mm)			CUSCINETTI PER TURBINE			
		B	D	W	RADIALI			ANGOLARI
<b>CARATTERISTICHE</b>	Cilindrico	3,175	6,350	2,380	 DR02A	 DR02B	 DR73B	 DA02A
	Flangiato	3,175	6,350	2,380	 DR13A	 DR13B		 DA13A
	Ribassato	3,175	6,350	2,380	 DR21A	 DR21B	 DR21H	 DA21J
	Cilindrico	3,175	6,350	2,779	 DR55A	 DR55B	 DR55F	 DA55B
	Flangiato	3,175	6,350	2,779	 DR01B	 DR01E		 DA01B
	Ribassato	3,175	6,350	2,779	 DR70B	 DR70K		 DA70B
	Unico	3,175	6,350	2,779	 DR56B	 DR54B		 DA54B

	TIPO	MISURE (mm)			CUSCINETTI PER TURBINE		
		B	D	W	RADIALI	ANGOLARI	
CARATTERISTICHE	Cilindrico	2,380	4,763	1,588	 DR04A		
	Cilindrico	2,380	4,763	2,380	 DR05B	 DR05E	
	Flangiato	2,380	4,763	2,380	 DR03B		
	Cilindrico	3,175	6,350	1,910	 DR74A		
	Cilindrico	3,175	7,938	2,779	 DR08A		
	Cilindrico	3,175	7,938	3,571	 DR09B	 DR09C	 DA09B
				 DR09D	 DR09F		

	TIPO	MISURE (mm)			CUSCINETTI PER TURBINE		
		B	D	W	RADIALI		ANGOLARI
CARATTERISTICHE	Cilindrico	2,35	5,00	1,50	 DR30A		
	Cilindrico	2,35	5,50	2,00	 DR83A		
	Cilindrico	3,00	7,00	2,00	 DR31A		
	Flangiato	3,00	7,00	2,50	 DR97A		
	Flangiato	3,00	7,00	2,00	 DR69A	 DR69B	 DA69A
	Cilindrico	4,00	7,00	2,00	 DR32A	 DR32B	 DA32A
	Cilindrico	4,00	9,00	2,50	 DR67A		

## CUSCINETTI cod 9A.... PER TURBINE

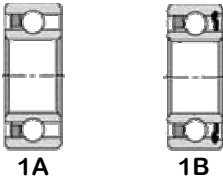
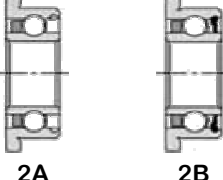
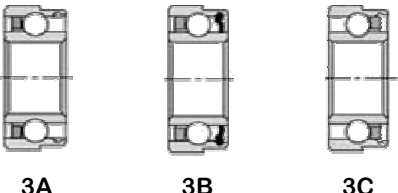
pag 6 di 10

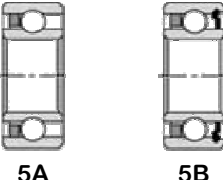
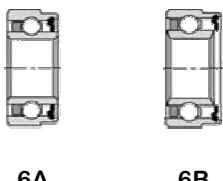
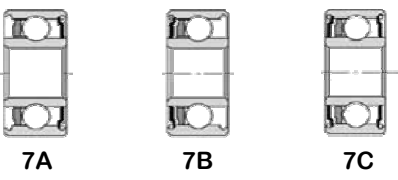
MISURE in mm			TIPO	CONFIGURAZIONE (sezione)	TIPO P/N
INTERNO (B)	ESTERNO (D)	SPESSORE (W)			
3,175	6,350	2,380	1		9A0051
			2		9A0013
			3		9A0021
3,175	6,350	2,779	4		9A0052
			5		9A0054
			6		9A0040 9A0053
3,175	7,937	3,571	7		9A0009

## TABELLA DI COMPARAZIONE DEI MICROCUSCINETTI

pag 7 di 10

CARATTERISTICHE DEI CUSCINETTI						TIPO	GABBIA					LUBRIFICANTE	MISURE					
MARCA	Modello	RADIALI	cod. 9A ... ( R )	C. ANGOLARI	cod. 9A ... ( A )	F = flangiato C = cilindrico R = ribassato U = unico	Phenolica	Torlon	Minipar	Minawear	Everclave		olio grasso	in mm.				
	(A) = anteriore (P) = posteriore					B = diam interno						D = diam esterno		W = spessore				
Kavo	Roll Air I & II	9A0076					1	2	3	4	5							
Adec	5000	DR01B	9A0050			F	1	2	3	4	5							
Adec	5100	DR01B	9A0050			F	1	2	3	4	5							
Dabi	RS350	DR01B	9A0050			F	1	2	3	4	5							
Atlante																		
DME	Aden	DR01B	9A0050			F	1	2	3	4	5							
Darby	True Speed	DR01B	9A0050	DA01B	9A0001	F	1	2	3	4	5							
Faro	BTC77	DR01B	9A0050	DA01B	9A0001	F	1	2	3	4	5							
Kinetc	Viper	DR01B	9A0050	DA01B	9A0001	F	1	2	3	4	5							
Mirco Mega	350	DR01B	9A0050	DA01B	9A0001	F	1	2	3	4	5							
Midwest	300SE (A)	DR01B	9A0050	DA01B	9A0001	F	1	2	3	4	5							
Midwest	Quiet-Air (A)	DR01B	9A0050	DA01B	9A0001	F	1	2	3	4	5							
Midwest	Quiet-Air L (A)	DR01B	9A0050	DA01B	9A0001	F	1	2	3	4	5							
Midwest	Tradition (A)	DR01B	9A0050	DA01B	9A0001	F	1	2	3	4	5							
Midwest	Tradition L (A)	DR01B	9A0050	DA01B	9A0001	F	1	2	3	4	5							
Midwest	Tradition Push Button	DR01B	9A0050	DA01B	9A0001	F	1	2	3	4	5							
NSK	Phatelus Series	DR01B	9A0050-812			F		2	3	4	5	L						
Shangai		DR01B	9A0050			F	1	2	3	4	5							
Castellini	Clean Air	DR01E	9A0037	DA01B	9A0001	F	1	2	3	4	5	L						
Castellini	High Power M	DR01E	9A0037	DA01B	9A0001	F	1	2	3	4	5	L						
Athena	AC 4000	DR02A	9A0051			C	1	2	3	4	5							
Chiradent	3200 & 3400	DR02A	9A0051			C	1	2	3	4	5							
Faro	S380	DR02A	9A0051			C	1	2	3	4	5							
KDM	Colibri	DR02A	9A0051			C	1	2	3	4	5							
Kinetic	Quantum (P)	DR02A	9A0051			C	1	2	3	4	5							
Midwest	300SE (P)	DR02A	9A0051	DA02A	9A0002	C	1	2	3	4	5							
Midwest	1000	DR02A	9A0051	DA02A	9A0002	C	1	2	3	4	5							
Midwest	8000	DR02A	9A0051	DA02A	9A0002	C	1	2	3	4	5							

3,175

6,35

2,779

2,38



## TABELLA DI COMPARAZIONE DEI MICROCUSCINETTI

pag 8 di 10

CARATTERISTICHE DEI CUSCINETTI						TIPO	GABBIA					LUBRIFICANTE	MISURE			
MARCA	Modello		RADIALI	cod. 9A ... ( R )	C. ANGOLARI	cod. 9A ... ( A )	F = flangiato C = cilindrico R = ribassato U = unico	Phenolica	Torlon	Minipar	Minawear		Everclave	L olio G grasso	in mm.	
	(A) = anteriore	(P) = posteriore										B = diam interno			D = diam esterno	W = spessore
Midwest	Quiet-Air	(P)	DR02A	9A0051	DA02A	9A0002	C	1	2	3	4	5		3,175	6,35	2,38
Midwest	Quiet-Air L	(P)	DR02A	9A0051	DA02A	9A0002	C	1	2	3	4	5				
Midwest	Tradition	(P)	DR02A	9A0051	DA02A	9A0002	C	1	2	3	4	5				
Midwest	Tradition L	(P)	DR02A	9A0051	DA02A	9A0002	C	1	2	3	4	5				
MTC	105		DR02A	9A0051	DA02A	9A0002	C	1	2	3	4	5				
NSK	Pana Air Series		DR02A	9A0051			C	1	2	3	4	5				
NSK	CH Series	(P)	DR02A	9A0051			C	1	2	3	4	5				
NSK	Match Series	(P)	DR02A	9A0051			C	1	2	3	4	5				
Siemens	3000		DR02B	9A0051			C	1	2	3	4	5				
TKD	Turbina Mini Master		DR02B	9A0051			C	1	2	3	4	5				
TKD	Thera		DR02B	9A0051			C	1	2	3	4	5				
W&H	200 & 300 Series		DR02B	9A0051-811			C	1	2	3	4	5	L			
Yoshida	H Series		DR02B	9A0051			C	1	2	3	4	5				
Yoshida	SL Series		DR02B	9A0051			C	1	2	3	4	5				
Northwest	First Air Std.		DR02D					1	2	3	4	5				
Northwest	First Air Mini		DR02D					1	2	3	4	5				
Midwest	Quiet-Air Mini	(A)	DR03B	9A0003			F	1	2	3	4	5		2,38	4,763	2,4
Midwest	Quiet-Air Mini	(P)	DR04A	9A0004			C	1	2	3	4	5				1,6
Sandri	Omicron		DR08A				C	1	2	3	4	5				2,8
Bien Air	Black Pearl		DR09B	9A0009			C	1	2	3	4	5				
Bien Air	Laboratory		DR09B	9A0009			C	1	2	3	4	5				
Dabi Atlante	PS		DR09B	9A0009			C	1	2	3	4	5		3,175	7,938	3,571
KMD	Maxtorque		DR09B	9A0009			C	1	2	3	4	5				
Ney	Hurricane		DR09B	9A0009			C	1	2	3	4	5				
TDK	Turbina Master		DR09B	9A0009			C	1	2	3	4	5				
Kavo	Extra Torque		DR09C	9A0009			C	1	2	3	4	5				

## TABELLA DI COMPARAZIONE DEI MICROCUSCINETTI

pag 9 di 10

CARATTERISTICHE DEI CUSCINETTI						TIPO	GABBIA					LUBRIFICANTE	MISURE		
MARCA	Modello	RADIALI	cod. 9A ... ( R )	C. ANGOLARI	cod. 9A ... ( A )	F = flangiato C = cilindrico R = ribassato U = unico	Phenolica	Torlon	Minipar	Minawear	Everclave		olio grasso	in mm.	
	(A) = anteriore (P) = posteriore					B = diam interno						D = diam esterno		W = spessore	
Star	Concentrix	DR09D	9A0009			C	1	2	3	4	5		3,175	7,938	3,571
Star	Futura	DR09D	9A0009			C	1	2	3	4	5				
Buffalo	220 Air Lab	DR09F	9A0009			C									
Kinetic	Quantum (A)	DR13A	9A0013			F	1	2	3	4	5		3,175	6,35	2,38
NSK	CH Series (A)	DR13A	9A0013			F	1	2	3	4	5				
NSK	Match Series (A)	DR13A	9A0013			F	1	2	3	4	5				
Beijing		DR21A	9A0021			R	1	2	3	4	5				
Dabi Atlante	MS350	DR21B	9A0021			R	1	2	3	4	5				
Kavo	Bella Torque 628	DR21B	9A0021-812			R	1	2	3	4	5				
Kavo	Magno 634	DR21B	9A0021-812			R	1	2	3	4	5				
Siemens	4000	DR21B	9A0021-812			R	1	2	3	4	5				
Siemens	TM1	DR21B	9A0021-812			R	1	2	3	4	5				
Borden	Silencer	DR21H	9A0021			R	1	2	3	4	5				
Star	Vista	DR54B	9A0132			U	1	2	3	4	5				
Star	Advantage	DR54B	9A0132	DA54B	9A0054	U	1	2	3	4	5				
Star	430K	DR54B	9A0132	DA54B	9A0054	U	1	2	3	4	5				
Bien Air	Ondine	DR55B	9A0052			C	1	2	3	4	5				
Bien Air	Prestige	DR55B	9A0052-811			C	1	2	3	4	5				
Faro	S400	DR55B	9A0052	DA55B	9A0055	C	1	2	3	4	5				
Faro	S405	DR55B	9A0052	DA55B	9A0055	C	1	2	3	4	5				
Faro	Delta	DR55B	9A0052	DA55B	9A0055	C	1	2	3	4	5				
Star	Ultra	DR55B	9A0052			C	1	2	3	4	5				
TKD	Titan	DR55B	9A0052			C	1	2	3	4	5				
W&H	100 Series	DR55B	9A0052	DA55B	9A0055	C	1	2	3	4	5				
W&H	700 & 800 Series	DR55B	9A0052	DA55B	9A0055	C	1	2	3	4	5				
W&H	Trend	DR55B	9A0052	DA55B	9A0055	C	1	2	3	4	5				
Yoshida	Standard (S-Q)	DR55B	9A0052			C	1	2	3	4	5				
MTC	7807	DR55D					1	2	3	4	5				

## TABELLA DI COMPARAZIONE DEI MICROCUSCINETTI

pag 10 di 10

CARATTERISTICHE DEI CUSCINETTI						TIPO	GABBIA					LUBRIFICANTE	MISURE		
MARCA	Modello	RADIALI	cod. 9A ... ( R )	C. ANGOLARI	cod. 9A ... ( A )	F = flangiato C = cilindrico R = ribassato U = unico	Phenolica	Torlon	Minipar	Minawear	Everclave		olio grasso	in mm.	
	(A) = anteriore (P) = posteriore					B = diam interno						D = diam esterno		W = spessore	
Champion	Champ Air Standard	DR56B	9A0056			U	1	2	3	4	5		3,175	6,35	2,779
Champion	Champ Miniature	DR56B	9A0056			U	1	2	3	4	5		3,175	6,35	2,779
Sandri	90	DR67A				C	1	2	3	4	5		4,0	9,0	2,5
Shofu	Lab Air Z (A)	DR70A	9A0040				1	2	3	4	5				
Kavo	Roll Air III	DR70B	9A0040	DA70B	9A0070	R	1	2	3	4	5		3,175	6,35	2,779
Kavo	Super Torque 625	DR70B	9A0040	DA70B	9A0070	R	1	2	3	4	5				
Kavo	Super Torque 630	DR70B	9A0040	DA70B	9A0070	R	1	2	3	4	5				
Kavo	Bella Torque 632	DR70B	9A0040	DA70B	9A0070	R	1	2	3	4	5				
Kavo	Super Torque 640	DR70B	9A0040	DA70B	9A0070	R	1	2	3	4	5				
Kavo	Bella Torque 642	DR70B	9A0040	DA70B	9A0070	R	1	2	3	4	5				
MTI	Lynx	DR70B	9A0040			R	1	2	3	4	5				
Siemens	TS1	DR70B	9A0040	DA70B	9A0070	R	1	2	3	4	5				
Chirana	Satur	DR70B-80	9A0040	DA70B-80	9A0070	R	1	2	3	4	5				
Prema															
Shofu	Lab Air Z (P)	DR70H	9A0040				1	2	3	4	5				
Kavo	Contact Air	DR70K	9A0053			R	1	2	3	4	5		3,175	6,35	2,8
Lares	330E	DR73B	9A0073			C	1	2	3	4	5				
Lares	557	DR73B	9A0073			C	1	2	3	4	5				
Lares	757	DR73B	9A0073			C	1	2	3	4	5				
Lares	757 Push Button (A)	DR73B	9A0073			C	1	2	3	4	5				
Lares	557 Push Button (P)	DR74A	9A0074-810			C	1	2	3	4	5				
Lares	757 Push Button (P)	DR74A	9A0074-810			C	1	2	3	4	5				2,38
Chiradent	401A	DR97A	9A0074-810			F	1	2	3	4	5		3,0	7,0	2,0